

2018 Legislative Review



Contact Information

250 East 500 South
SLC, UT 84114
(801) 538-7500



Education Bills by the Numbers



Bills Introduced



Bills Passed

67%

Bill approval rating





Numbers at a Glance

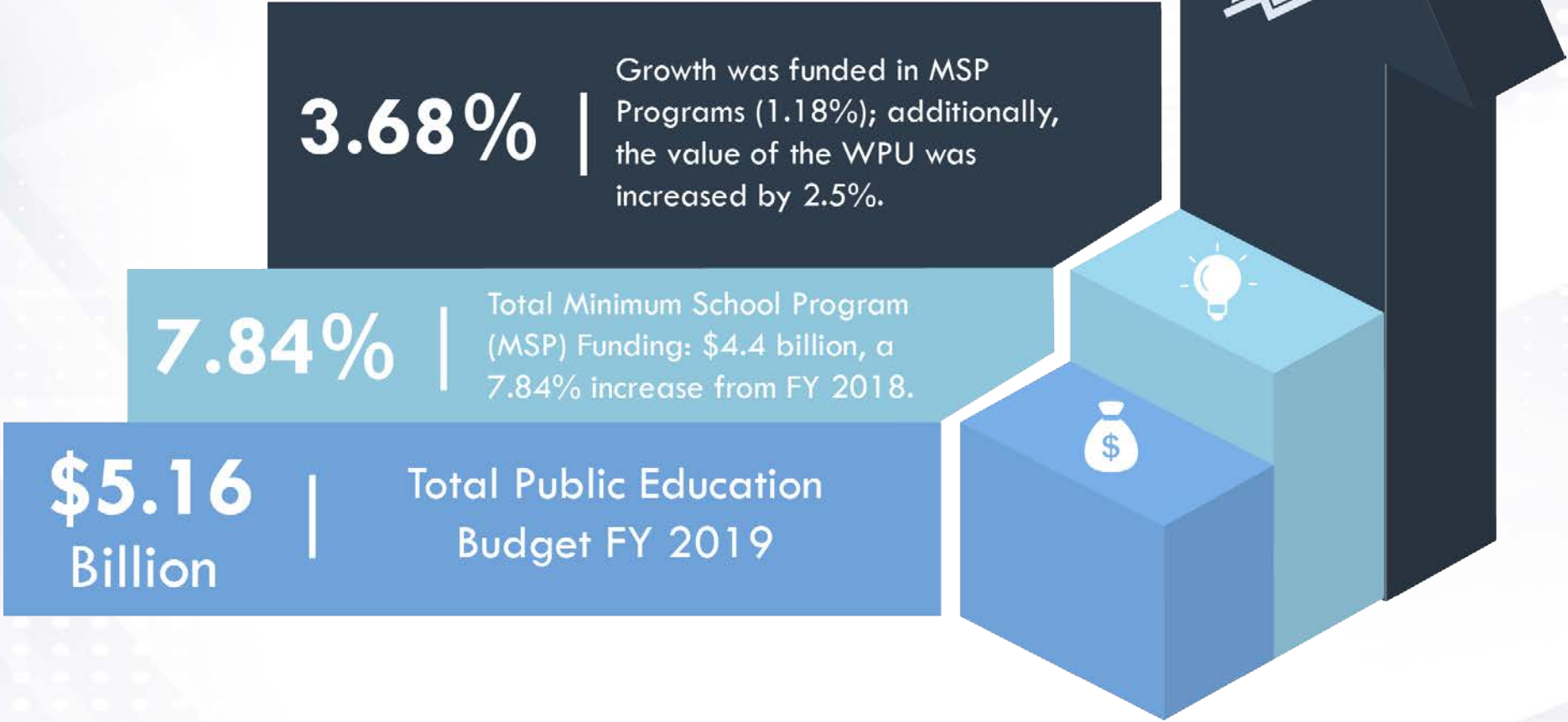

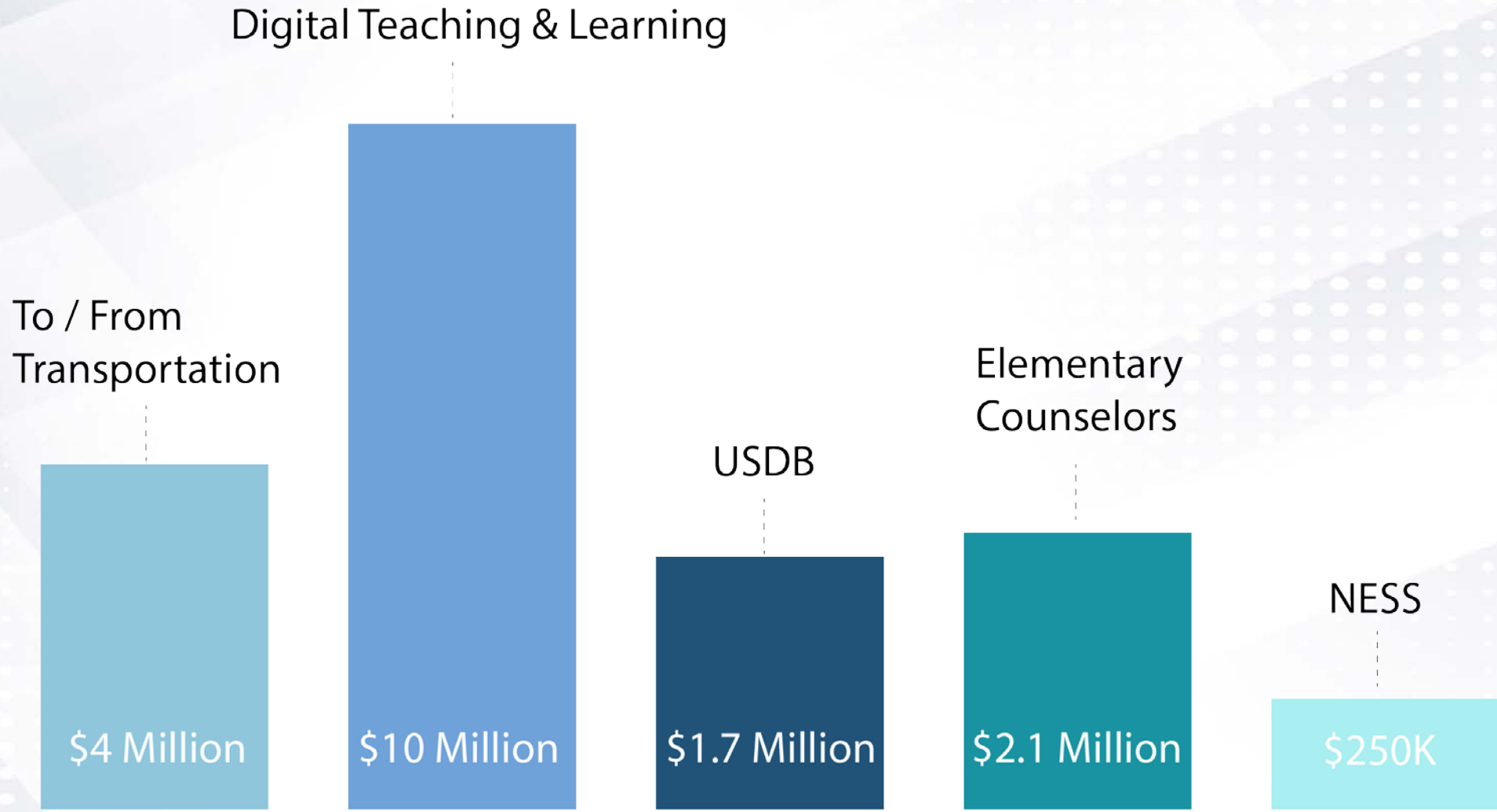

Program Increases

Notable Program Highlights



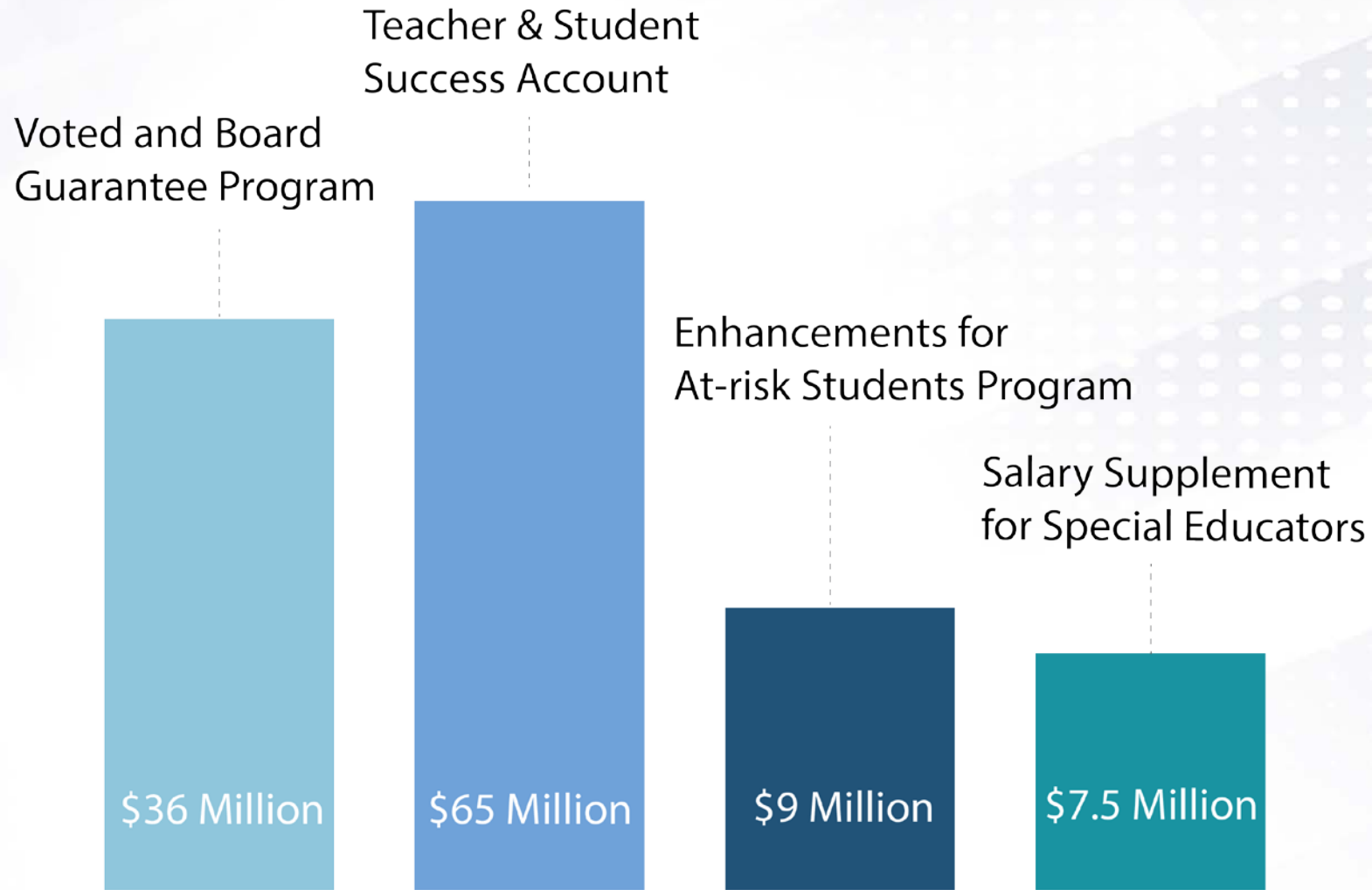

Teacher & Student Support

Notable Teacher & Student Support Highlights



Notable Education Bills

HB 46



Educator Modifications

Modifies the public education code regarding educator licensing to allow the Board to establish licensing requirements in rule, including the establishment of associate, professional and LEA-specific licenses.

HB 264



Elementary School Counselor Program

Authorizes the Board to award grants to local education agencies to provide targeted school-based mental health supports in elementary schools.

SB 194



Early Literacy Program

Renames the K-3 Reading Improvement Program; amends requirements for participation. Requires the Board to provide support to LEAs failing to meet their goals.

HB 317



Special Education Amendments

Extends an eligible student's entitlement for a free, appropriate public education for students who turn 22 during a school year until the end of the school year.

HB 286



Reproductive Ed Amendments

Modifies instruction in health to include instruction in the harmful effects of pornography and refusal skills; amends definitions for required parental consent.



Notable Education Bills

HB 132



Juvenile Justice Modifications

Clarifies the duties and allowed responsibilities of school resource officers and for two years allows LEAs to refer certain students who have committed lower level discipline offenses to law enforcement or court.

HB 233



Teacher Salary Supplement Revisions

Provides a salary supplement of \$4,100 to a teacher who has a degree in special education and is assigned to teach special education.

HB 293



Tax Rebalancing Revisions

Amends the calculation of the basic levy for a 5-year period, resulting in an increase in revenue for schools, and establishes the weighted pupil unit value and equity pupil tax rates.

HB 408



Public Education Amendments

Creates the Utah Leading through Effective, Actionable, and Dynamic Education (ULEAD) research and innovation program at USBE.

HB 313



Public School Revisions

Enacts provisions related to the powers and duties of charter school authorizers; requires the Board to adopt rules establishing minimum standards for charter schools.



Early Learning

SB 194

Early Literacy Program

SB 115

UPSTART Program Amendments

SB 127

Reading Software Program Amendments

HB 380

Utah School Readiness Initiative Amendments



Behavioral Support / Mental Health

HB 132

Juvenile Justice
Modifications

SB 145

School Funding
Revisions



Behavioral Support / Mental Health

HB 264

Elementary School
Counselor Program

HB 370

Suicide Prevention
and Medical
Examiner
Provisions

HB 308

Telehealth Mental
Health Pilot
Program

HB 234

Compulsory
Education Revisions



Behavioral Support / Mental Health

HR 1

House Resolution
Urging Restorative
Justice in Utah's
Education System

SCR 12

Concurrent
Resolution on
Reducing Gang
Activity



Special Education



HB 317

Special Education
Amendments

HB 233

Teacher Salary
Supplement
Revisions

SB 153

Carson Smith
Scholarship
Amendments

Educators

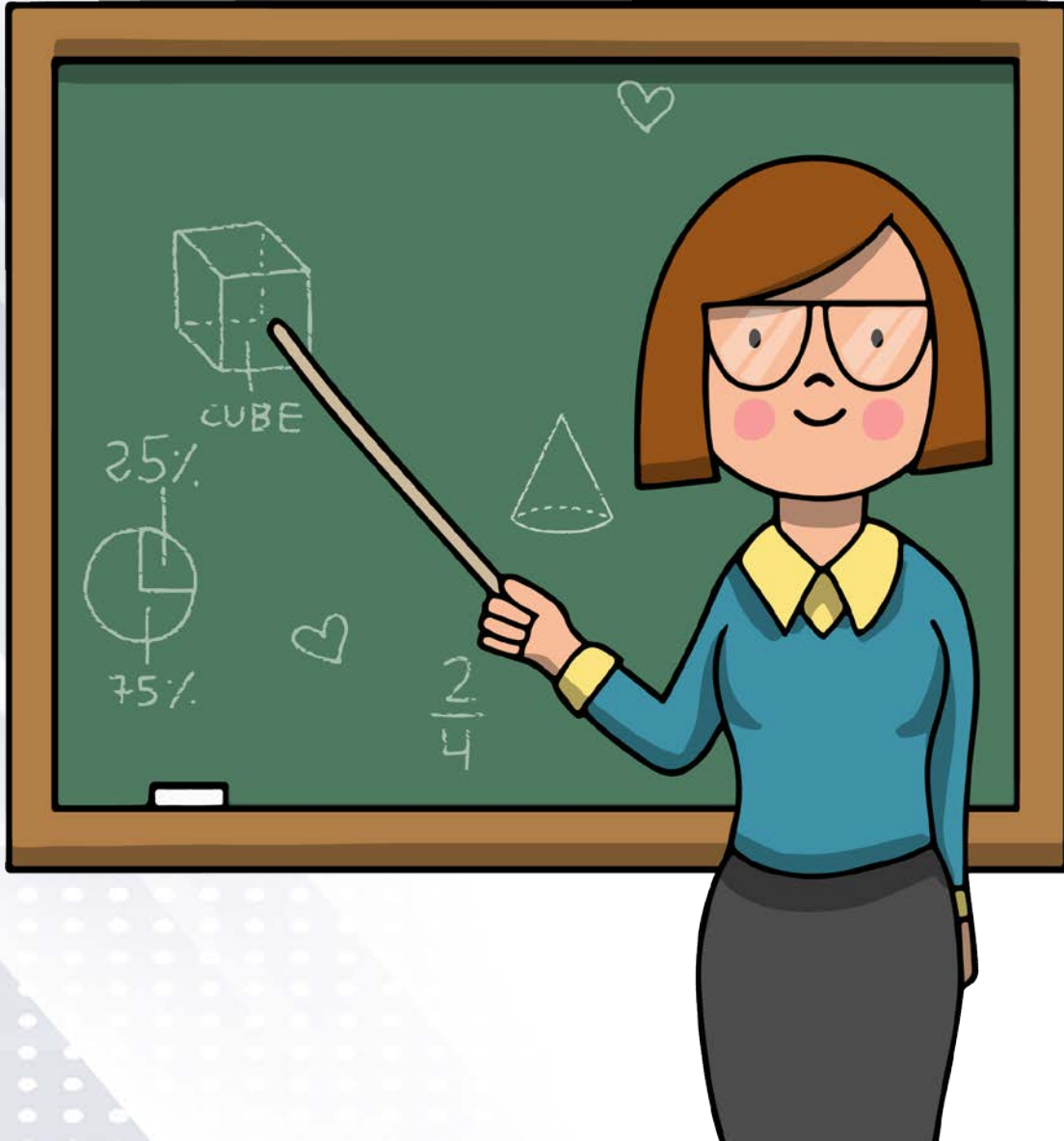

HB 46

Educator Licensing
Modifications

* \$500,000 ongoing added
for Teacher Supply Money

Educators

HB 439

Coordinated
Penalties for Sexual
Abuse

HB 237

Concurrent
Enrollment
Enhancements

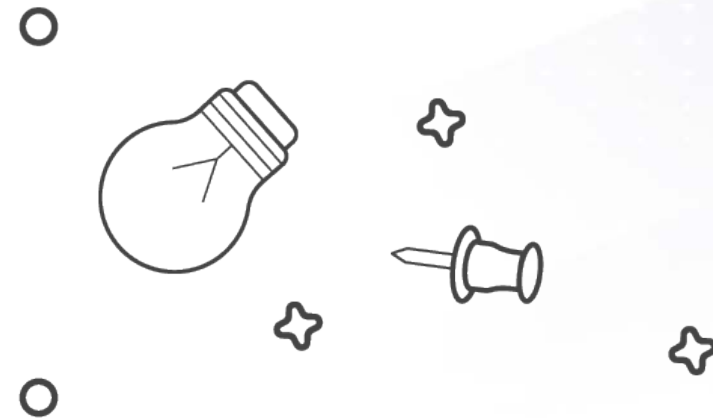
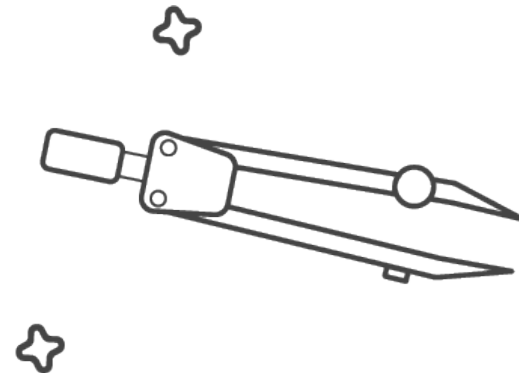

Programs



HB 408

Public Education
Amendments

SB 132

Competency-based
Education
Amendments

SB 117

Language
Immersion Program
Amendments

Programs

SB 202

After School
Program
Amendments

HB 286

Reproductive
Education
Amendments

HB 404

Land Trusts
Protection and
Advocacy Act

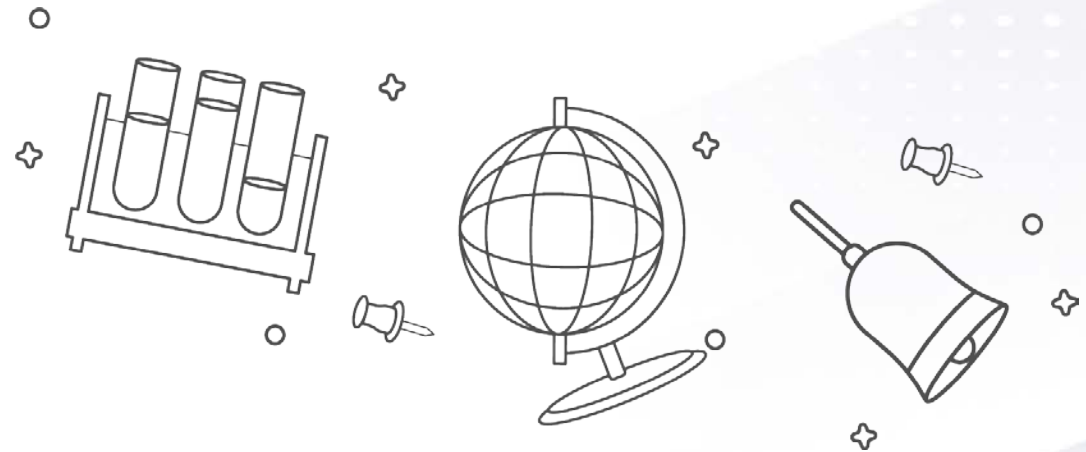

Our Schools Now Compromise



- Our Schools Now will suspend its Initiative, not submit it for the ballot.
- The group will continue to advocate for a 10 cent increase in the gas tax, on the non-binding opinion question for November 2018

HB 293

Tax Rebalancing
Revisions

HB 491

Election Law
Changes

SJR 20

Joint Resolution
Submitting a
Question to Voters

H.B. 293 Tax Rebalancing Revisions

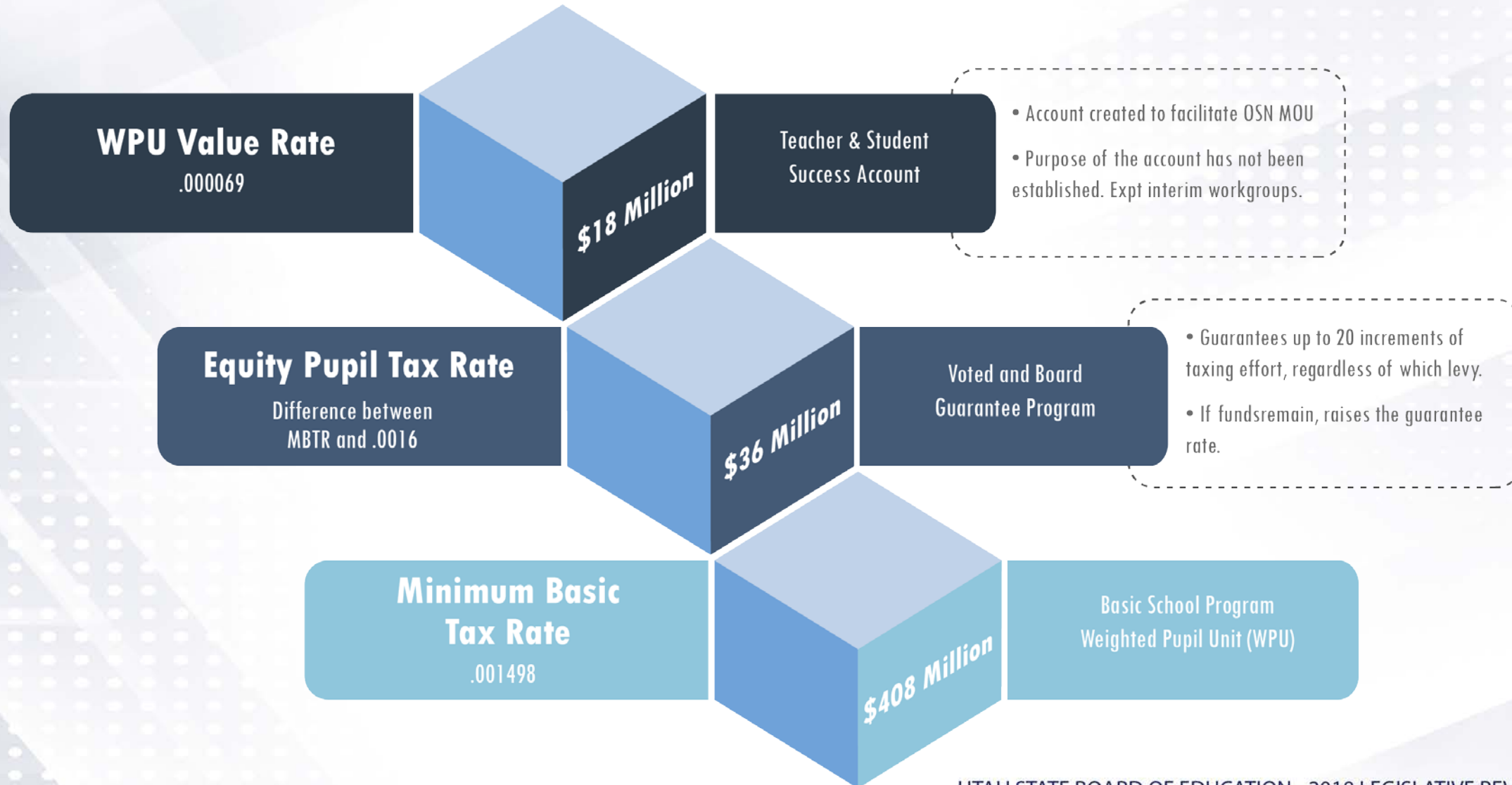

Reporting

HB 227

Minimum School
Program Reporting
Modifications

HB 230

Related to Basic
School Programs
Review

SB 198

Public School
Disciplinary Action
Amendments



Student Data Privacy

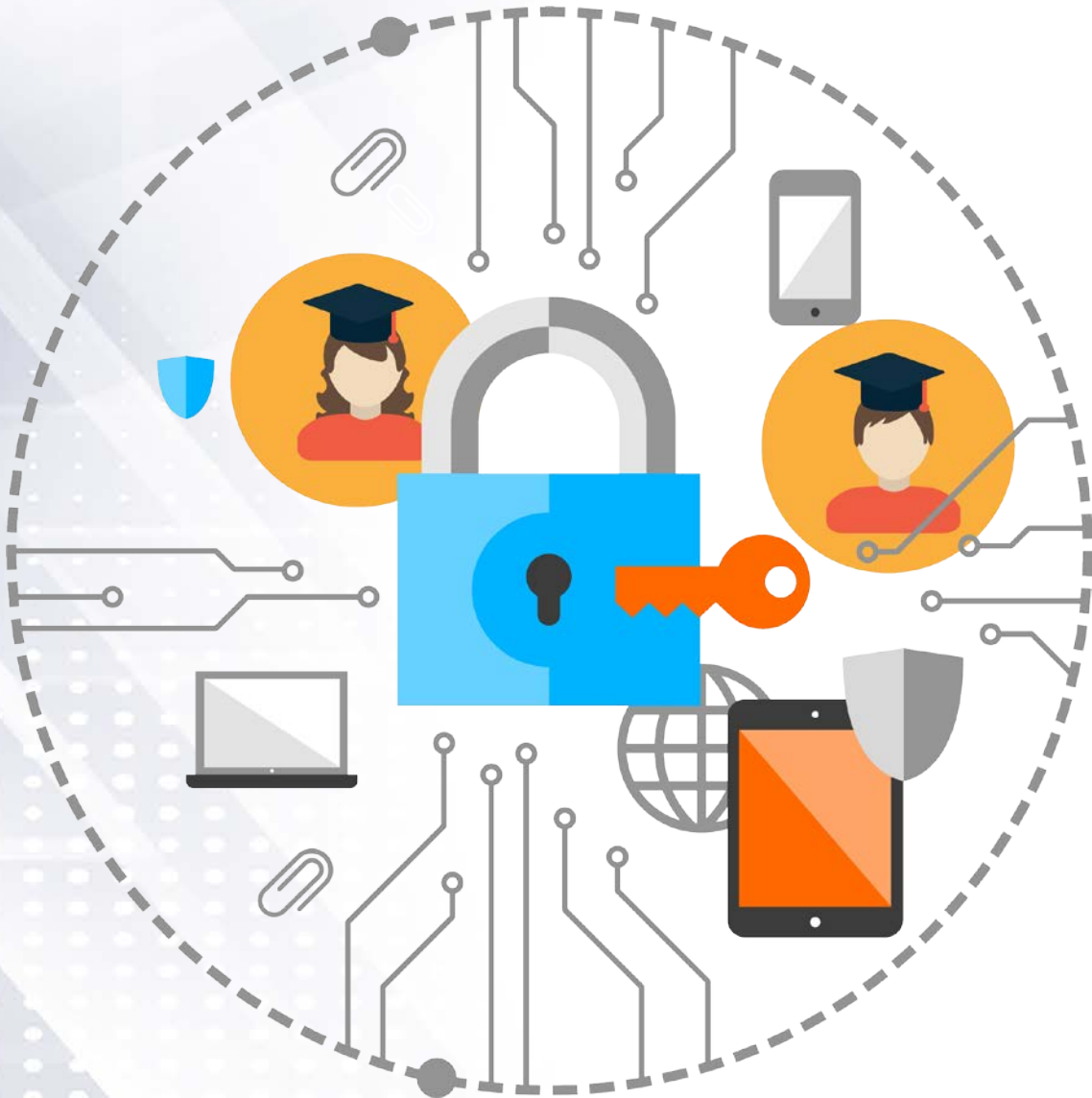

SB 207

Student Data
Protection
Amendments

HB 370

Suicide Prevention
and Medical
Examiner Provisions

School Funding

SB 124

Budget Deadline
Amendments

SB 232

School
Transportation
Amendments

SB 144

Local Funding
Education
Technology

SB 232

School
Transportation
Amendments

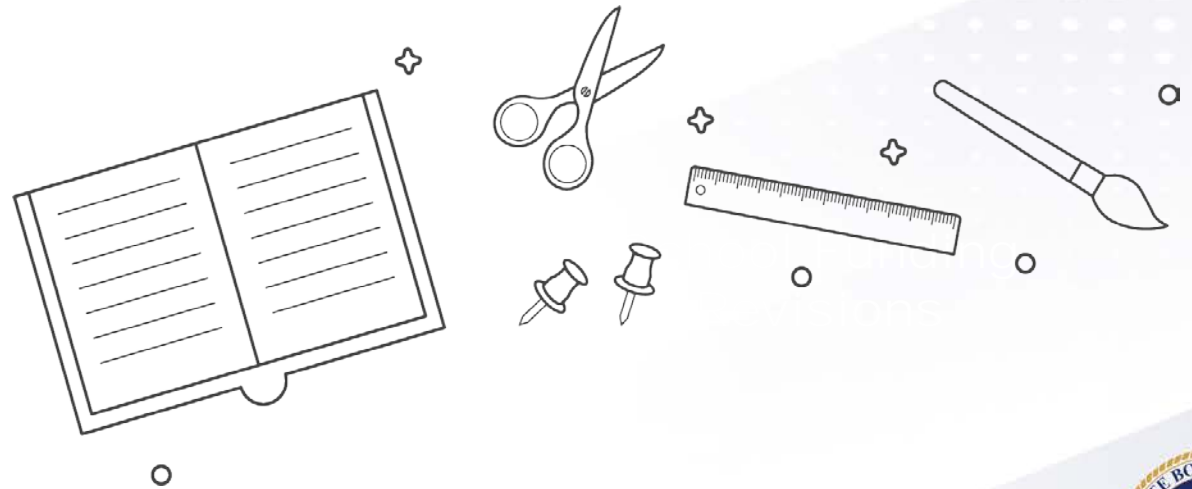

School Districts and Charter Schools



HB 456

Alcohol
Amendments

HB 236

Public Education
Reference Check
Amendments

HB 327

Rural Online
Initiative

School Districts and Charter Schools

HB 228

Child Sexual Abuse
Prevention Training
Amendments

SB 87

School Security
Locks

SB 137

Amendments
Related to
Government
Records

SB 103

Strategic Workforce
Investments



School Districts and Charter Schools

SB 148 Public Education Enrollment Applications

SB 176 Student Internships Liability



Charter Schools



HB 313

Public School
Revisions

HB 231

Charter School
Funding
Amendments

HB 245

Charter School
Proximity
Amendments

Charter Schools

SB 70

Human Resource
Requirements

SB 173

State Charter
School Board
Amendments



State Board



HB 306

State Board of
Education Revisions

HB 20

Political Activities
and Elections

State Board



HB 179

State Training and
Certification
Requirements

HB 72

Communications of
Governmental Entity
Employees and Officers

Retirement / Benefits



HB 28

Retirement Systems
Amendments

HB 29

Public Employees
Long-term Disability
Act Amendments

HB 147

Retirement
Forfeiture for
Employment
Related Offenses

State Employees

HB 34

State Employee
Leave Policy
Amendments



Thank You

Questions?

Phone (801) 538-7500

Sydnee Dickson

Angie Stallings

Patty Norman

Scott Jones

sydnee.dickson@schools.utah.gov

angie.stallings@schools.utah.gov

patty.norman@schools.utah.gov

scott.jones@schools.utah.gov

